

Order Date: _____

Shipping Address: _____

Name: _____

Phone #: _____

Email: _____

Patient Name: _____

1. SELECT DESIGN: Original (Default) Finish Only (*) | Matte or High Gloss Finish Only () | Add. Color Options. See Reverse (▲)**

- | | | | | | | | |
|---------------------------------|---|-----------------------------------|---------------------------------------|-------------------------------------|---|-----------------------------------|------------------------------------|
| <input type="checkbox"/> Allens | <input type="checkbox"/> Deep Eyes | <input type="checkbox"/> Fadilah | <input type="checkbox"/> Houndstooth▲ | <input type="checkbox"/> LSDeener*▲ | <input type="checkbox"/> Mythic | <input type="checkbox"/> Pines* | <input type="checkbox"/> Stealth |
| <input type="checkbox"/> Alpine | <input type="checkbox"/> Demarche▲ | <input type="checkbox"/> Flora | <input type="checkbox"/> Imperialist | <input type="checkbox"/> L-Trainer | <input type="checkbox"/> Nouveau* | <input type="checkbox"/> Racer▲ | <input type="checkbox"/> Steen |
| <input type="checkbox"/> Apollo | <input type="checkbox"/> Digital Rococo | <input type="checkbox"/> Gaia | <input type="checkbox"/> Janz Pro | <input type="checkbox"/> Modena** | <input type="checkbox"/> Nouveau Colorway*▲ | <input type="checkbox"/> Roe 2.0 | <input type="checkbox"/> Victorian |
| <input type="checkbox"/> Baller | <input type="checkbox"/> Digi Camo* | <input type="checkbox"/> Geomecon | <input type="checkbox"/> Jennings | <input type="checkbox"/> Monarch | <input type="checkbox"/> OM | <input type="checkbox"/> Roth | <input type="checkbox"/> Wings |
| <input type="checkbox"/> Bloom | <input type="checkbox"/> Digi Solo**▲ | <input type="checkbox"/> Glide | <input type="checkbox"/> John-Paul | <input type="checkbox"/> Moto** | <input type="checkbox"/> Paisley | <input type="checkbox"/> Royale | |
| <input type="checkbox"/> Deco | <input type="checkbox"/> Exius 2.0 | <input type="checkbox"/> Hi-Top | <input type="checkbox"/> Khloris | <input type="checkbox"/> Moto GP** | <input type="checkbox"/> Palms | <input type="checkbox"/> Salt Pro | |
| <input type="checkbox"/> Deener | <input type="checkbox"/> EXO | <input type="checkbox"/> HIFI▲ | <input type="checkbox"/> L750 | <input type="checkbox"/> MTL* | <input type="checkbox"/> Paradigm | <input type="checkbox"/> SOLO▲ | |

2. COVER LENGTH:

- | | | | | | | | | | | | | | | | | | | | | |
|-------------------------------|---------------------------------|-------------------------------|---------------------------------|-------------------------------|---------------------------------|-------------------------------|---------------------------------|-------------------------------|---------------------------------|-------------------------------|---------------------------------|-------------------------------|---------------------------------|-------------------------------|---------------------------------|-------------------------------|---------------------------------|-------------------------------|---------------------------------|-------------------------------|
| <input type="checkbox"/> 10in | <input type="checkbox"/> 10.5in | <input type="checkbox"/> 11in | <input type="checkbox"/> 11.5in | <input type="checkbox"/> 12in | <input type="checkbox"/> 12.5in | <input type="checkbox"/> 13in | <input type="checkbox"/> 13.5in | <input type="checkbox"/> 14in | <input type="checkbox"/> 14.5in | <input type="checkbox"/> 15in | <input type="checkbox"/> 15.5in | <input type="checkbox"/> 16in | <input type="checkbox"/> 16.5in | <input type="checkbox"/> 17in | <input type="checkbox"/> 17.5in | <input type="checkbox"/> 18in | <input type="checkbox"/> 18.5in | <input type="checkbox"/> 19in | <input type="checkbox"/> 19.5in | <input type="checkbox"/> 20in |
|-------------------------------|---------------------------------|-------------------------------|---------------------------------|-------------------------------|---------------------------------|-------------------------------|---------------------------------|-------------------------------|---------------------------------|-------------------------------|---------------------------------|-------------------------------|---------------------------------|-------------------------------|---------------------------------|-------------------------------|---------------------------------|-------------------------------|---------------------------------|-------------------------------|

** please ensure there is a 1/2 to 1 inch gap between the top of the footshell and bottom of the cover to accommodate movement.

3. COVER CIRCUMFERENCE:

- | | |
|---|---|
| <input type="checkbox"/> A (11.5-12.5 inches) | <input type="checkbox"/> D (16-18 inches) |
| <input type="checkbox"/> B (13-14 inches) | <input type="checkbox"/> E (18.5-20.5 inches) |
| <input type="checkbox"/> C (14.5-15.5 inches) | (E only available for BK) |

4. LEFT / RIGHT:

- | |
|------------------------------------|
| <input type="checkbox"/> Left Leg |
| <input type="checkbox"/> Right Leg |

5. TOP SHAPE:

- | |
|--|
| <input type="checkbox"/> Arch (for AK) |
| <input type="checkbox"/> Dip (for BK) |

6. BACK SHAPE:

- | |
|---|
| <input type="checkbox"/> Sport Cut (easier to don/doff) |
| <input type="checkbox"/> Racer Back (more coverage) |

7. MAIN COLOR

- | | | | |
|--------------------------------------|---------------------------------------|---|----------------------------------|
| <input type="checkbox"/> 14K Gold | <input type="checkbox"/> Cobalt | <input type="checkbox"/> Purple | <input type="checkbox"/> Teal |
| <input type="checkbox"/> Army Green | <input type="checkbox"/> Forest Green | <input type="checkbox"/> Racecar Yellow | <input type="checkbox"/> White |
| <input type="checkbox"/> Baby Blue | <input type="checkbox"/> Grey Green | <input type="checkbox"/> Red | <input type="checkbox"/> Nude #1 |
| <input type="checkbox"/> Baby Pink | <input type="checkbox"/> Lime Green | <input type="checkbox"/> Rose Gold | <input type="checkbox"/> Nude #2 |
| <input type="checkbox"/> Baby Yellow | <input type="checkbox"/> Maroon | <input type="checkbox"/> Seafoam Green | <input type="checkbox"/> Nude #3 |
| <input type="checkbox"/> Black | <input type="checkbox"/> Navy | <input type="checkbox"/> Silver | <input type="checkbox"/> Nude #4 |
| <input type="checkbox"/> Charcoal | <input type="checkbox"/> Orange | <input type="checkbox"/> Spanish Gold | <input type="checkbox"/> Nude #5 |

8. DETAIL COLOR

- | | | | |
|--------------------------------------|---------------------------------------|---|----------------------------------|
| <input type="checkbox"/> 14K Gold | <input type="checkbox"/> Cobalt | <input type="checkbox"/> Purple | <input type="checkbox"/> Teal |
| <input type="checkbox"/> Army Green | <input type="checkbox"/> Forest Green | <input type="checkbox"/> Racecar Yellow | <input type="checkbox"/> White |
| <input type="checkbox"/> Baby Blue | <input type="checkbox"/> Grey Green | <input type="checkbox"/> Red | <input type="checkbox"/> Nude #1 |
| <input type="checkbox"/> Baby Pink | <input type="checkbox"/> Lime Green | <input type="checkbox"/> Rose Gold | <input type="checkbox"/> Nude #2 |
| <input type="checkbox"/> Baby Yellow | <input type="checkbox"/> Maroon | <input type="checkbox"/> Seafoam Green | <input type="checkbox"/> Nude #3 |
| <input type="checkbox"/> Black | <input type="checkbox"/> Navy | <input type="checkbox"/> Silver | <input type="checkbox"/> Nude #4 |
| <input type="checkbox"/> Charcoal | <input type="checkbox"/> Orange | <input type="checkbox"/> Spanish Gold | <input type="checkbox"/> Nude #5 |

(▲ if you are ordering a design with more than two color selections please specify here ▲)

9. MATERIAL SELECTION

(Heavy Duty option available or A only incurs additional charge)

- Default Heavy Duty

10. STRAP COLOR







- Black (Default)
 Tan
 Red
 Blue

11. COVER FINISH

- Original (Default)
 Matte
 High Gloss

12. ADJUSTMENTS?

() Extra measurement(s) needed. See reverse for required info.

- | | |
|--|---|
| <input type="checkbox"/> No. | <input type="checkbox"/> High Profile/ Blade/ Hydraulic/ or Microprocessor Foot  |
| <input type="checkbox"/> Polycentric/ 4 Bar Knee  | <input type="checkbox"/> Rotationplasty  |
| <input type="checkbox"/> Total Knee  | <input type="checkbox"/> Symes (Sport Back Only)  |
| <input type="checkbox"/> Through Knee (TK) | <input type="checkbox"/> Release Button  |
| <input type="checkbox"/> Osseo (only available for AK) | <input type="checkbox"/> Revo Socket  |

POLYCENTRIC/ 4 BAR KNEE

- (1): Knee Unit Measurement; &
- Make & Model of Knee.

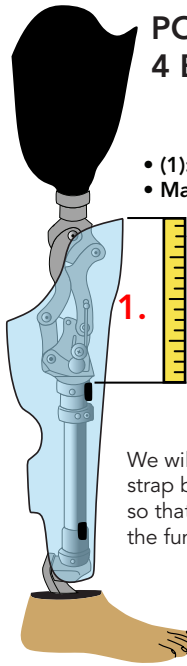

We will make sure to move the top strap below the knee mechanism so that there is no interference with the functionality of the knee.

TOTAL KNEE

- (1): Knee Unit Measurement.

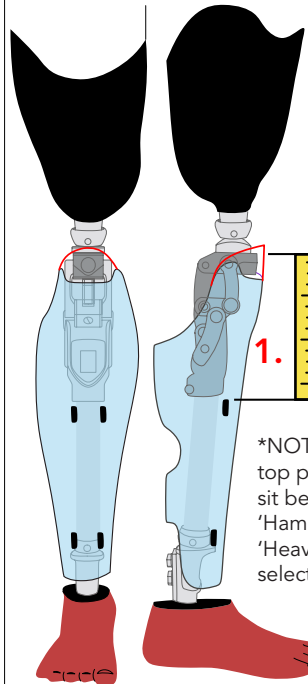

*NOTE: we will change the top profile of the cover to sit below the Total Knee 'Hammer', UNLESS the 'Heavy Duty' Material is selected.

HIGH PROFILE, BLADE, MICROPROCESSOR, OR HYDRAULIC FOOT

- (1): Measure from Top of Foot Shell to Top of Foot Unit.

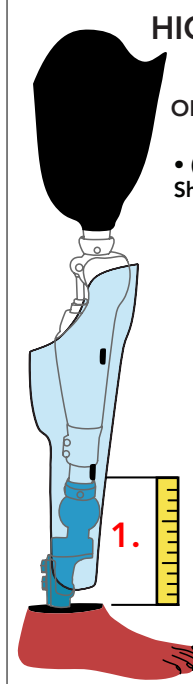

We will make sure to move the bottom strap above the build height of the foot unit so that there is no interference with the functionality of the foot.

ROTATIONPLASTY

- (1): measure from tip of pointed toe to top of footshell;
- (2): measure from just below the 'heel/knee' of the socket to the top of the footshell.

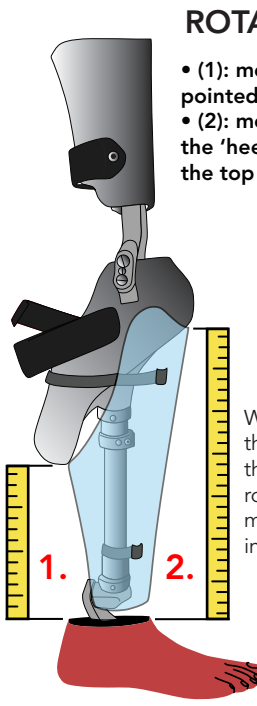

We have developed this shape to streamline the geometry of the rotationplasty set-up and make it feel less bulky and in turn more flattering.

RELEASE BUTTON

- (1): measure from top of the footshell to center of release button;
- include if button placement is: Medial, Lateral, or Posterior.

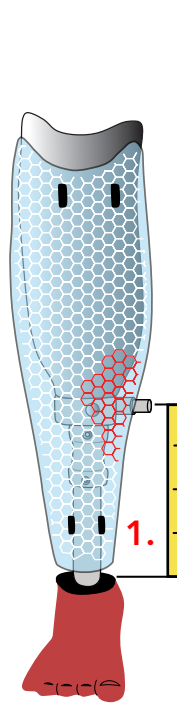

This includes release valves, pinlock buttons or any geometry that protrudes out from the pylon or socket that could interfere with the cover.

We will adjust the artwork on the cover and remove perforations in that general area.

No access holes will be manufactured on the cover. Adjustments ensure any holes drilled into the cover won't affect overall integrity or leave unwanted edges.

REVO SOCKET

- (1): measure from top of footshell to center of dial;
- include if dial placement is: Medial, Lateral, or Posterior.

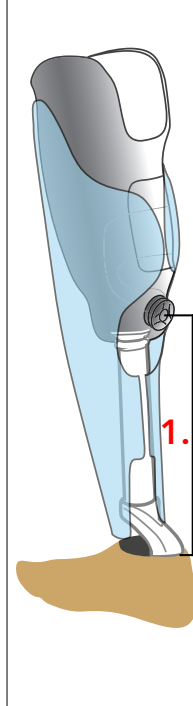

Covers will work best if the REVO Dial is mounted on the **posterior distal** end of the socket. Our covers already have an opening in the back that allows for easy access.

If your dial is medial or lateral, or you have any concerns about overall fit, please reach out with photos PRIOR to ordering.



THROUGH KNEE

We will NOT require additional measurements for a through-knee cover.

By selecting 'Through Knee' on the Adjustment Section of the order form we will make necessary adjustments to the shape on our end.

SYMES

Due to the individuality of SYMES Sockets, we require:

- The widest circumference near top of socket; 
- The widest circumference at ankle;  &
- Photos of the prosthesis (front, side, & back).

*SYMES Covers can ONLY be ordered with the 'Sport Back'.

MEASUREMENTS/ NOTES

(**Please reach out with photos PRIOR to ordering if you have any concerns about your cover.**)

BK COVERS

BK LENGTH:

Measure from the lowest dip in the front of the socket to the top of the footshell.

****Please remove a half inch to 1 inch from the overall length to ensure there is a gap between the top of footshell and bottom of the cover to allow for movement.**

****If the socket has a protruding brim, measure from just below the brim, so the cover is able to rest below the protruding geometry.**

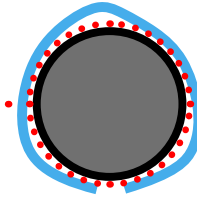
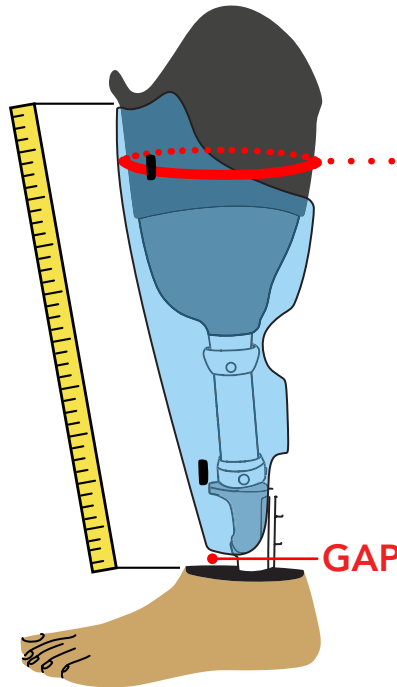

BK CIRCUMFERENCE:

Measure the widest circumference of the socket.

Width sizes are bracketed. Please select the bracket your measurement falls under.

****If a suspension sleeve is normally worn, ensure measurement is taken with the suspension sleeve on.**

AK COVERS

AK LENGTH:

Measure from the apex of the mechanical knee to the top of the footshell.

****Please remove a half inch to 1 inch from the overall length to ensure there is a gap between the top of footshell and bottom of the cover to allow for movement.**

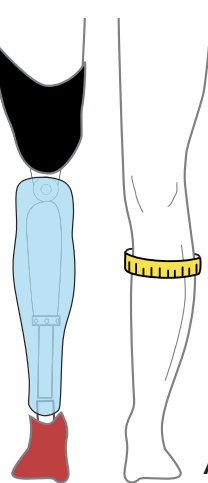
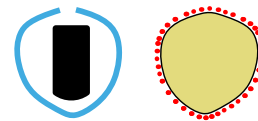
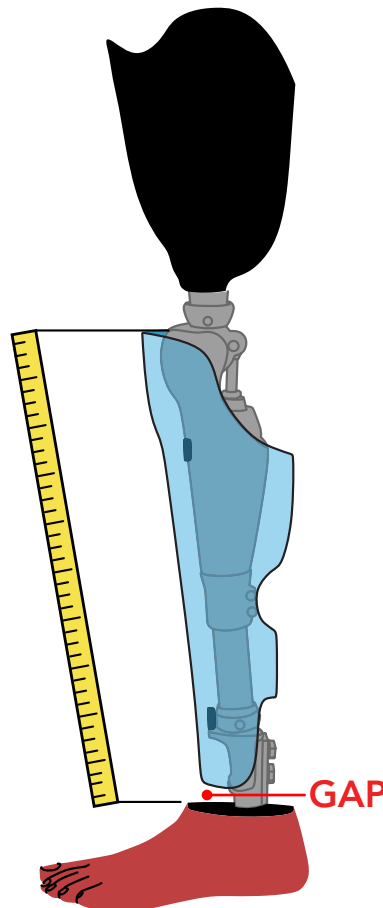

AK CIRCUMFERENCE:

Measure the circumference of the widest part of the sound limb.

Width sizes are bracketed. Please select the bracket your measurement falls under.

**** If ordering a bilateral AK set, use best judgement for width selection.**



DÉMARCHE

- **Main Color:** will be the color used for the BORDER & INSIDE of the cover
- **Detail Color:** will be the color used for the SHIN area



DIGI SOLO

- This cover comes in only ONE color. Choose same color for both MAIN & DETAIL



HIFI

- In addition to the MAIN & DETAIL color, you will have the option to include a third accent color:
- **Dot Color** (Optional): small accent on cover. If no third color is requested, it will be painted the same as the DETAIL color



HOUNDSTOOTH

- **Main Color:** acts as the TOP HALF color & BORDER color
- **Detail Color:** acts as the BOTTOM HALF color
- Note: Design Lines will always be black



LSDEENER

- **Main Color:** SHIN Color, used for bottom 2/3rds of cover
- **Detail Color:** used for all detail lines on the cover
- **Top Cuff Color:** used for top 1/3rd of cover
- **Sunray #1:** Sunrays will be painted with alternating colors
- **Sunray #2:** Sunrays will be painted with alternating colors
- **Star Color:** Small Star at top of cover



NOUVEAU COLORWAY

- **Main Color:** is the only color you will be able to choose & acts as the dominant color of the cover
- **Detail Color:** will ALWAYS be 14K Gold with accent flowers that are always: Baby Pink, Orange, Red, & Seafoam Green



RACER

- In addition to the MAIN & DETAIL color, you will have the option to include a third accent color:
- **Skull & Number Color** (optional): the fill color used for the skull and number at the top of the cover



SOLO

- This cover comes in only ONE color. Choose same color for both MAIN & DETAIL